

# Webb Torque Specification Guidelines

The purpose of this publication is to assist users with safe installation and maintenance practices while maintaining optimum performance of their wheel-end equipment. If additional information is required, please refer to TMC Recommended Practices: 217D, 222C, 237A, 656, and 662.

## Hub Piloted with Flange Nut (8 & 10 Stud Hubs)

Applied to M22 x 1.5 studs with two-piece flange nuts • Recommended torque oiled: 450 to 500 ft-lbs

**Step 1.** Place a drum pilot pad at the 12:00 o'clock position. Apply two drops of 30 weight oil between the nut and the nut flange, and two drops to the outermost 2 or 3 threads of the wheel stud. For corrosive environments, apply a light coating of anti-seize to the mounting pads of the hub as well as the pilot diameter of the brake drum to ease installation and removal.

**Note:** Avoid getting any lubricant on the mating surfaces of the hub flange, drum flange, or disc wheel mounting flange areas.

**Step 2.** Starting with the top nut, tighten all flange nuts to 50 ft-lbs using the sequence shown at right.

**Step 3.** Tighten all flange nuts to the recommended torque of 450-500 ft-lbs using the sequence shown at right.

**Step 4.** Check all disc wheels for proper positioning on pilots and proper seating against flange.

Recheck torque after first 50 to 100 miles of service or reference TMC RP 237A, "Torque Checking Guidelines For Disc Wheels" for individual fleet maintenance alternatives.

### Tightening Sequence

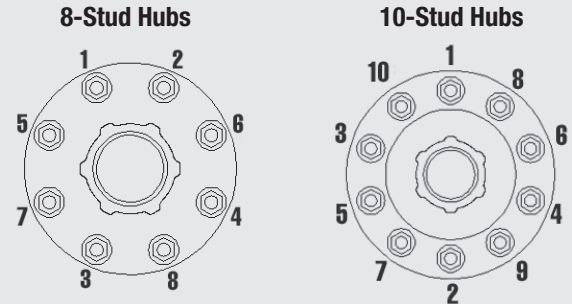

## Stud Piloted with Double Cap Nuts (6 & 10 Stud Hubs)

Applied to 3/4 - 16 and 1 1/8 - 16 fastener sizes • Recommended torque dry: 450 to 500 ft-lbs

### Inner Cap Nuts

**Step 1.** Place a drum pilot pad at the 12:00 o'clock position. For corrosive environments, apply a light coating of anti-seize to the mounting pads of the hub as well as the pilot of the brake drum to ease installation and removal. **Note:** Avoid getting any lubricant on the mating surfaces of the hub flange, drum flange, or disc wheel mounting flange areas. Starting with the top nut, tighten all inner cap nuts to 50 ft-lbs using the sequence shown at the right.

**Step 2.** Tighten all inner cap nuts to the recommended torque of 450 to 500 ft-lbs, dry, using the sequence shown at right.

### Outer Cap Nuts

**Step 1.** Place a drum pilot at the 12:00 o'clock position. Then, starting with the top nut, tighten all outer cap nuts to 50 ft-lbs using the sequence shown at right.

**Step 2.** Tighten all outer cap nuts to the recommended torque of 450 to 500 ft-lbs using the sequence shown at right.

**Step 3.** Check disc-wheels for proper positioning on pilots and proper seating against flange.

Recheck torque after first 50 to 100 miles of service or reference TMC RP 237A, "Torque Checking Guidelines For Disc Wheels" for individual fleet maintenance alternatives.

NOTE: In all applications where an aluminum disc wheel is to be installed, a special inner cap nut must be substituted for a standard inner cap nut.

### Tightening Sequence

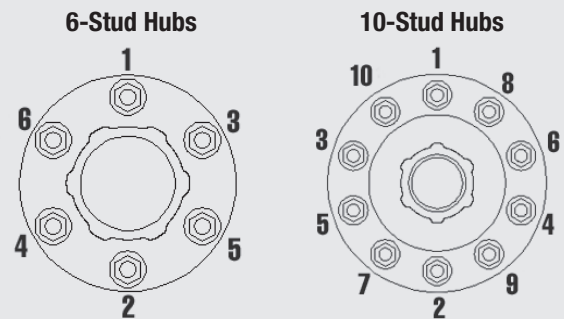

## Mount Identification

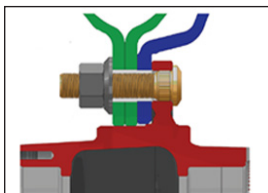

FN Mount (Flange Nut)

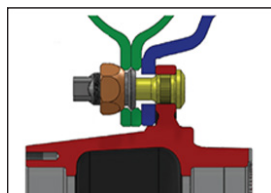

BSN Mount (Ball Seat Nut)



[www.webbwheel.com](http://www.webbwheel.com)

Contact your local Webb Wheel Products supplier for training that can cut your operating costs!



# Webb Torque Specification Guidelines

The purpose of this publication is to assist users with safe installation and maintenance practices while maintaining optimum performance of their wheel-end equipment. If additional information is required, please refer to TMC Recommended Practices: 217D, 222C, 237A, 656, and 662.

## 3, 5 and 6 Spoke Wheels

Recommended torque dry: 200 to 260 ft-lbs (Applies to ¾-10 fastener sizes)

**Tighten clamps evenly in the sequence shown at right.**

**Heel-Less Clamps:** Do not depend on a fulcrum at the bottom of the clamp to produce the force to wedge the rims. Heel of clamp does not touch wheel.

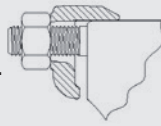

**Heel-Type Clamps:** Gap permissible but not required. If gap exceeds 1/4" or if clamp bottoms out before reaching 80% of recommended torque, check to insure that the proper clamps and spacers are being used.

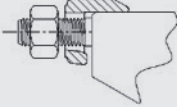

Recheck torque after first 50 to 100 miles of service or reference TMC RP 237A, "Torque Checking Guidelines For Disc Wheels" for individual fleet maintenance alternatives.

**IMPORTANT:** Do not overtorque! Rim clamp does not have to heel. Overtorquing can deform rim spacer and damage back flange.

## Tightening Sequence

3-Spoke Wheel

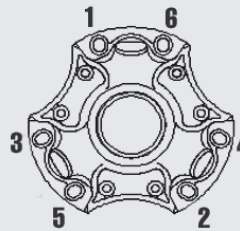

5-Spoke Wheel

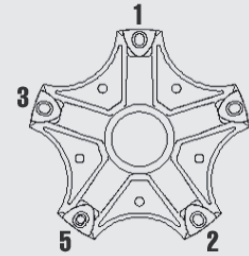

6-Spoke Wheel

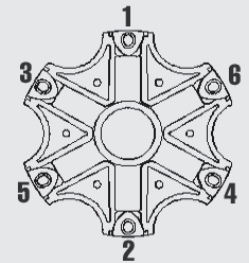

## Drive Studs and Hub Cap Bolt Torque

### Recommended Dry Torque Values

Description	Thread Size	Torque Requirements ft-lbs Min/Max
Drive studs/ axle installation torque	1/2 - 20	80/90
	5/8 - 18	175/185
	3/4 - 16	250/275

## Bolt-On ABS Ring

### Recommended Dry Torque Values

Description	Thread Size	Torque Requirements ft-lbs Min/Max
Screws For Bolt-On ABS Ring	# 8 - 32	15/20

## Brake Drum or Rotor Assembly Torque Requirements

### For Mounting Bolts or Nuts: Grade 8 Fasteners

Thread Size	Tighten/Loosen	Torque Requirements ft-lbs Min/Max	Thread Size	Tighten/Loosen	Torque Requirements ft-lbs Min/Max
5/8 - 18	Rotate bolt or nut	150/200	3/4 - 16 wheels	Rotate nut	275/300
5/8 - 18 through holes	Rotate nut	150/175	3/4 - 16 hubs	Rotate nut	100/225
3/4 - 10	Rotate nut	250/275	1 - 14	Rotate nut	175/225



[www.webbwheel.com](http://www.webbwheel.com)

Contact your local Webb Wheel Products supplier for training that can cut your operating costs!

